

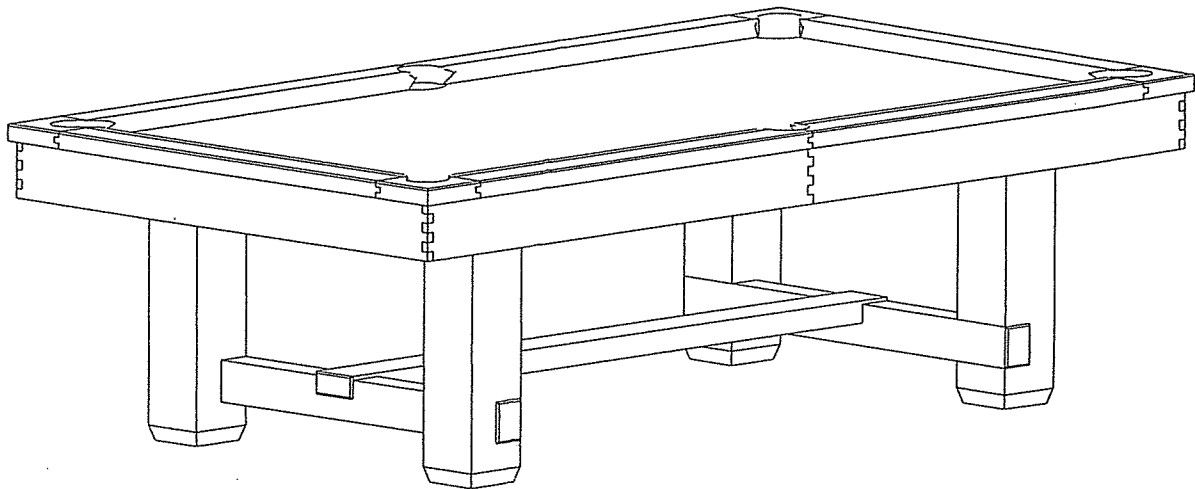









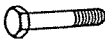

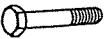

29-2920278
29-2920288

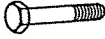
8' *RENO/TAHOE*





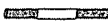
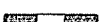



RENO/TAHOE TABLE ASSEMBLY INSTRUCTIONS













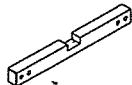

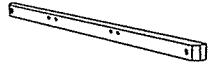

REPLACEMENT PARTS LIST (HARDWARE)

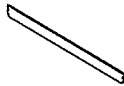
PACKAGE	ITEM #	SAMPLE	DESCRIPTION	QTY.
LEG/PANEL	H1		HEX BOLT 3/8" X 3-3/4"	12
	H2		FLAT WASHER 3/8" I.D.	12
	H3		HEX BOLT 3/8" X 6-1/2"	8
	H4		FLAT WASHER 3/8" I.D.	16
	H5		HEX NUT 3/8" I.D.	8
BEAM/BLOCK	H6		HEX HEAD CROSS BOLT 5/16" x 3 - 1/6"	16
	H7		FLAT WASHER 5/16" I.D.	16
	H8		HEX BOLT 3/8" X 5 - 1/8"	4
	H9		FLAT WASHER 5/16" I.D.	8
	H10		HEX NUT 3/8" I.D.	4
	H11		HEX HEAD CROSS BOLT 5/16" x 2"	4
	H12		FLAT WASHER 5/16" I.D.	4
RAIL/POCKET/SLATE	H13		FLAT HEAD SCREW 3/8" X 2-3/4"	12
	H14		STUD BOLT 5/16" x 5 - 1/2"	2
	H15		STUD BOLT 5/16" x 3 - 1/2"	8
	H16		FLAT WASHER 5/16" I.D.	4
	H17		HEX NUT 5/16" I.D.	4

REPLACEMENT PARTS LIST (HARDWARE)

PACKAGE	ITEM #	SAMPLE	DESCRIPTION	QTY.
RAIL/POCKET/SLATE	H18		HEX HEAD CROSS BOLT 5/16" x 1"	24
	H19		FLAT WASHER 5/16" I.D.	24
	H20		HEX HEAD CROSS BOLT 5/16" x 1 - 1/2"	12
	H21		FLAT WASHER 5/16" I.D.	12
	H22		HEX HEAD CROSS BOLT 5/16" x 2 - 1/2"	18
	H23		DOME WASHER 3/8" I.D.	18
	H24		FLAT HEAD SCREW #10 x 5/8"	24

REPLACEMENT PARTS LIST

PACKAGE	ITEM #	SAMPLE	DESCRIPTION	QTY.
LEG	1		R- LEG	2
	2		L- LEG	2
	3		SHORT LEG BEAM	2
	4		LONG LEG BEAM	1
FRAME (PANEL)	5		SIDE CABINET	2
	6		END CABINET	2
	7		LEFT SIDE APRON	2
	8		RIGHT SIDE APRON	2
	9		END APRON	2
	10		APRON JOINT CONNECTOR BLOCK	2
	11		APRON JOINT CORNER BLOCK	4
	12		LONG WOODEN BLOCK	4
	13		SHORT WOODEN BLOCK	4
BEAM	14		ONE HOLE CROSS BEAM	2
TOP RAIL	15		TOP RAIL LEFT SIDE	2
	16		TOP RAIL RIGHT SIDE	2

REPLACEMENT PARTS LIST









PACKAGE	ITEM #	SAMPLE	DESCRIPTION	QTY.
			TOP RAIL END	2
POCKET	17		TOP RAIL CORNER	4
	18		SIDE POCKET	2
	19		CORNER POCKET	4
SLATE	20		SLATE (LEFT)	1
	21		SLATE (CENTER)	1
	22		SLATE (RIGHT)	1
	23		CLOTH	1

FIG.1

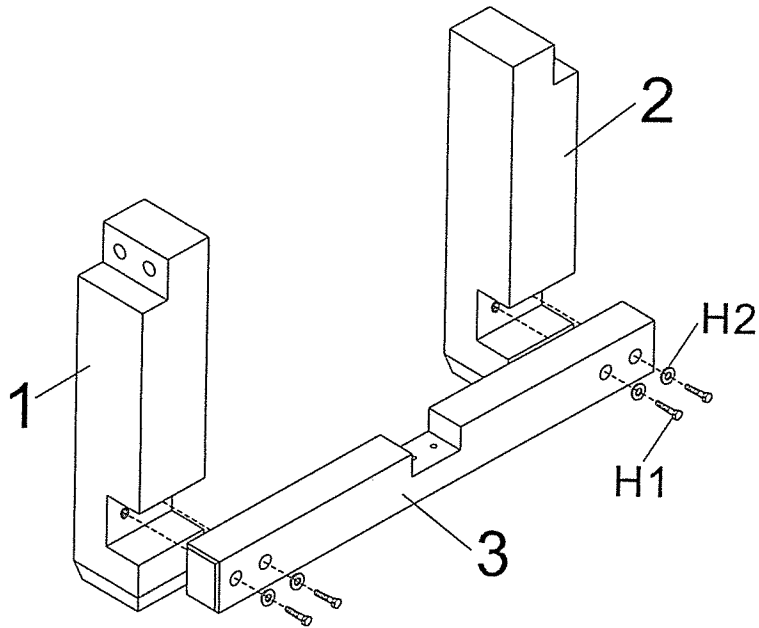

FIG.2

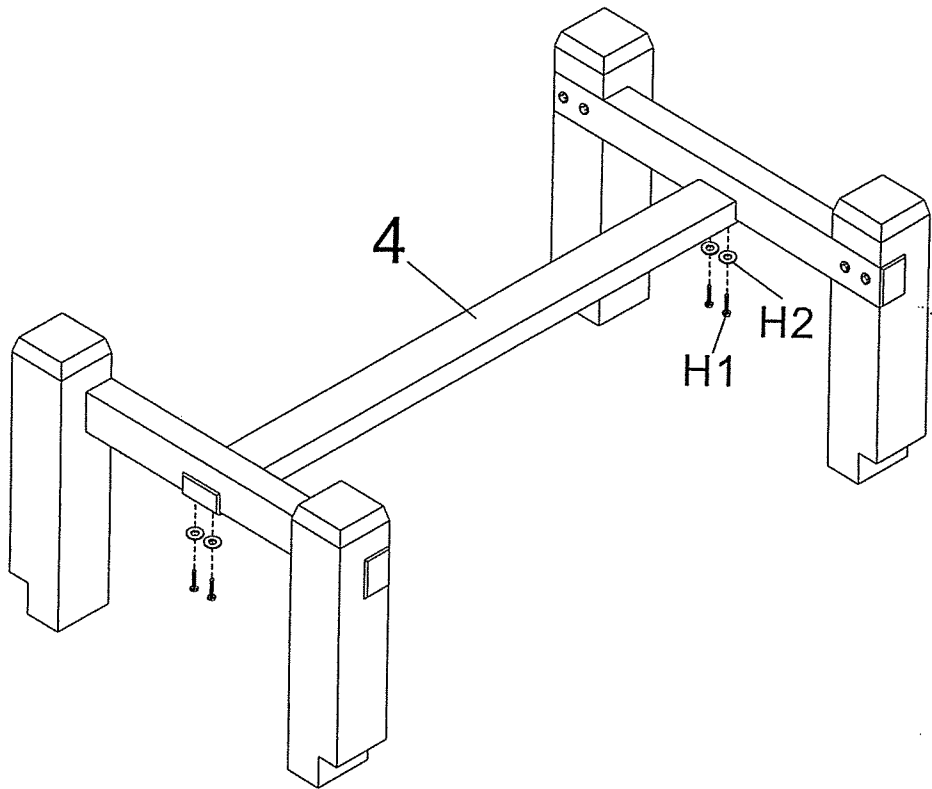

FIG.3

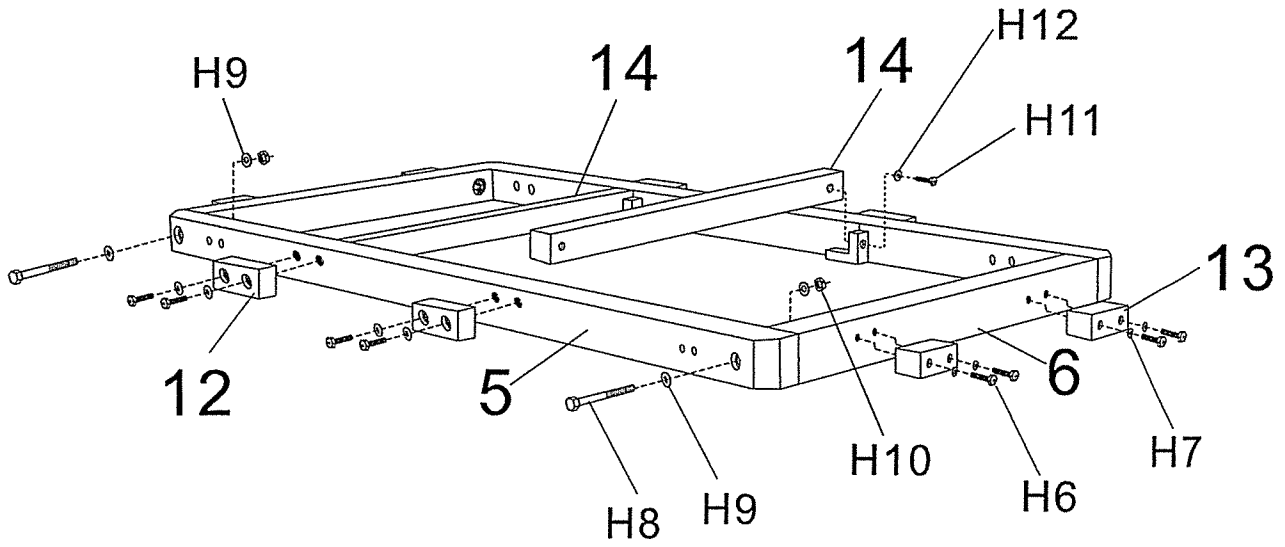

FIG.4

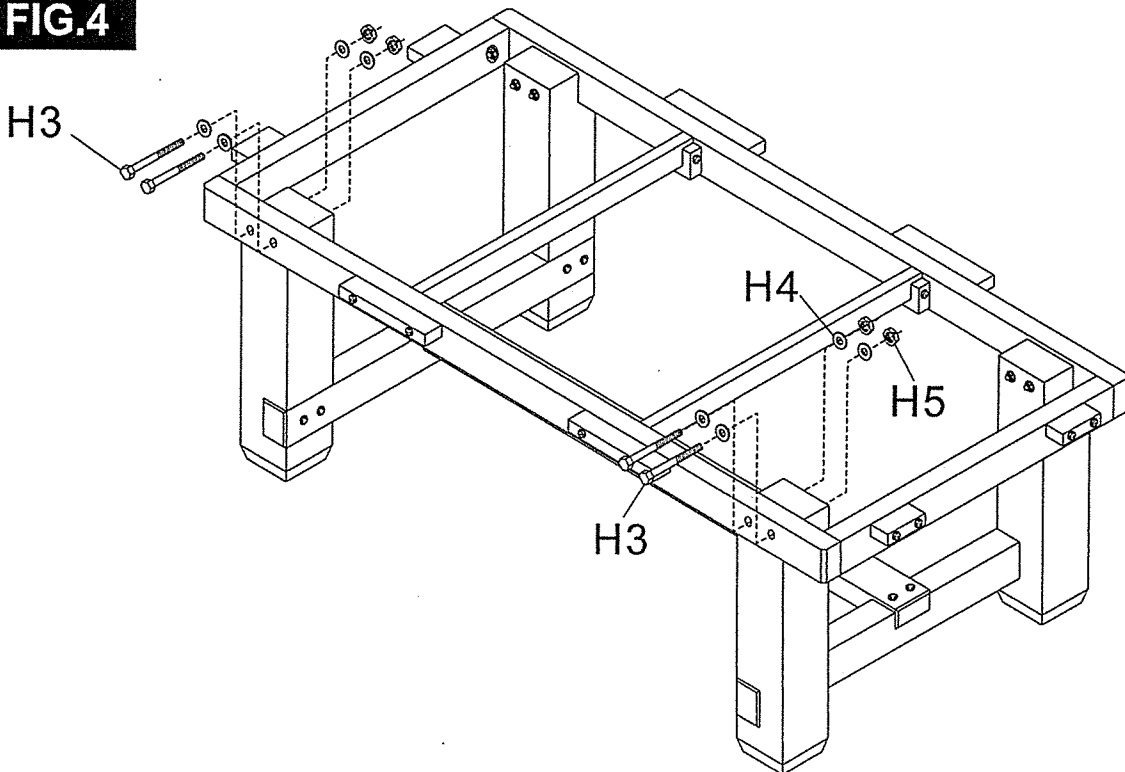

FIG.5

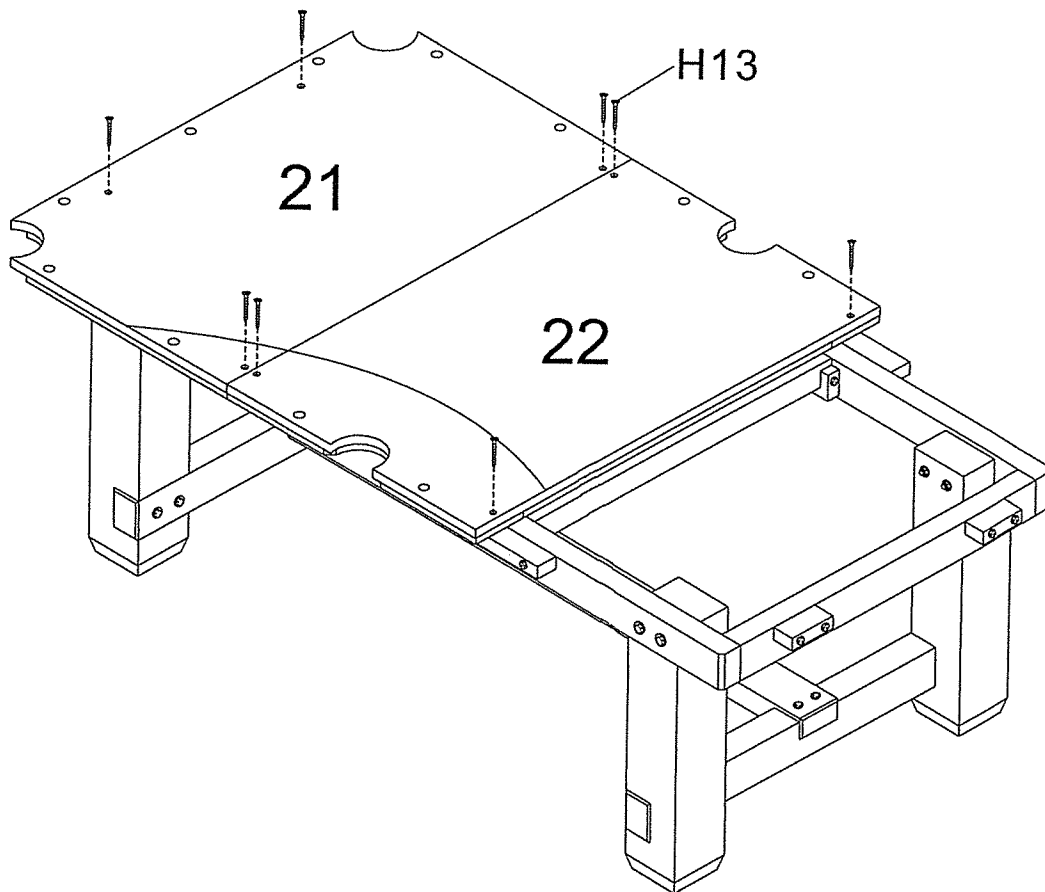

FIG.6

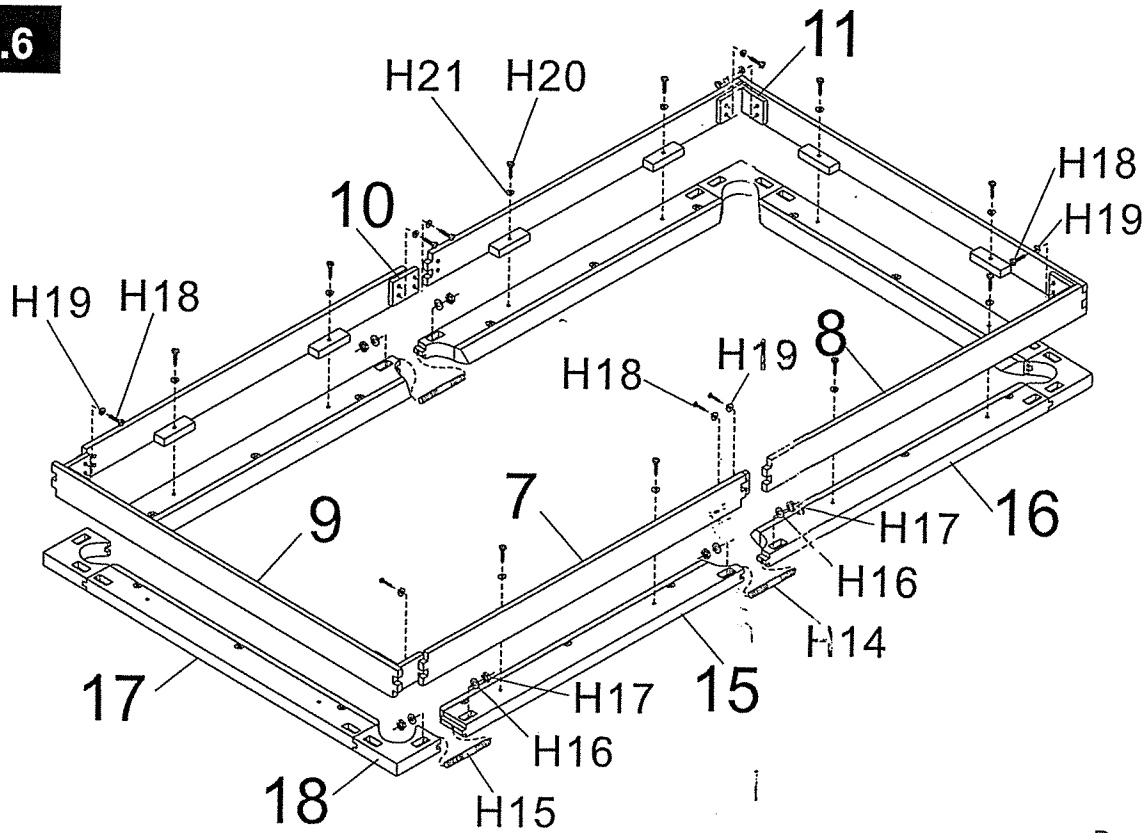
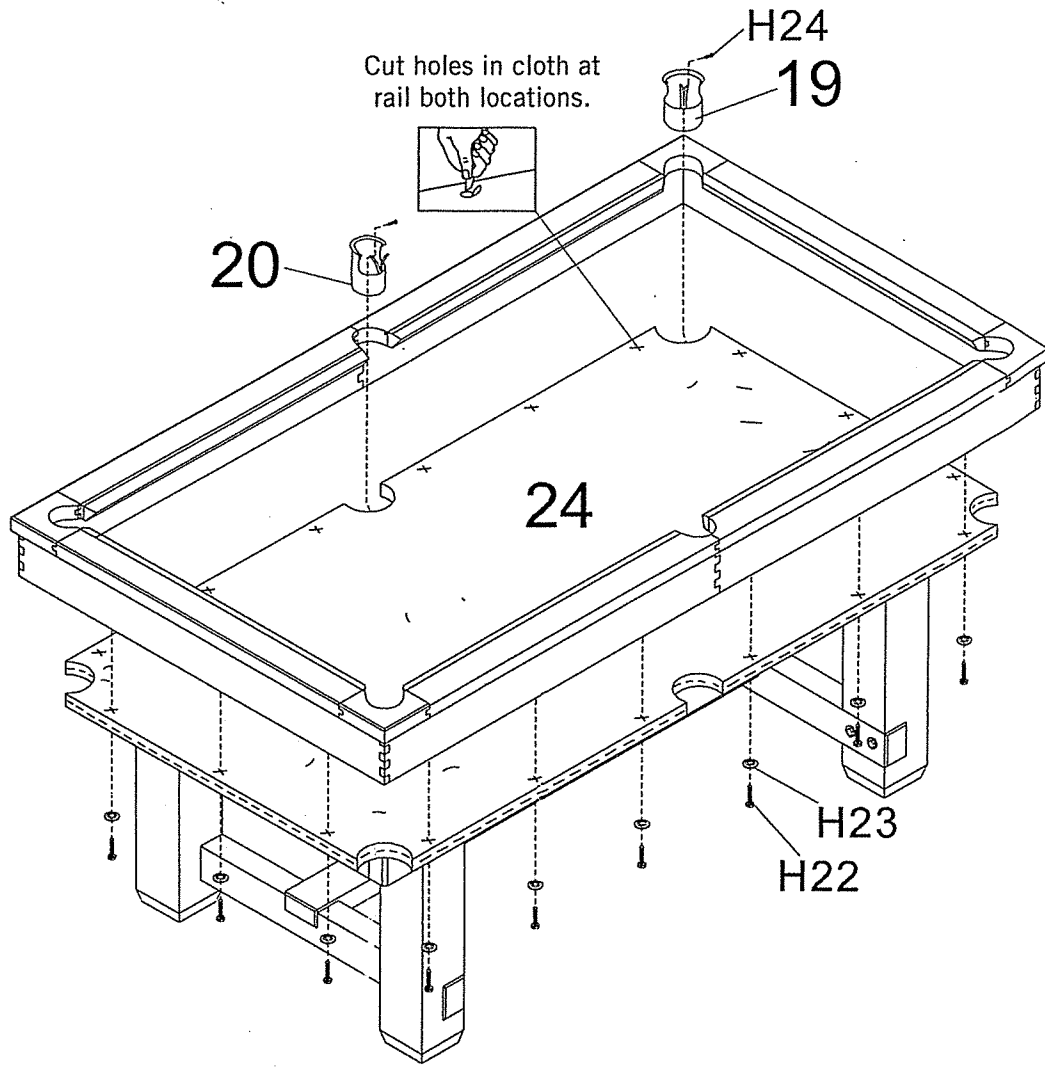

FIG.7



FINISH

