

ITEM NO:IM-7' OUTDOOR

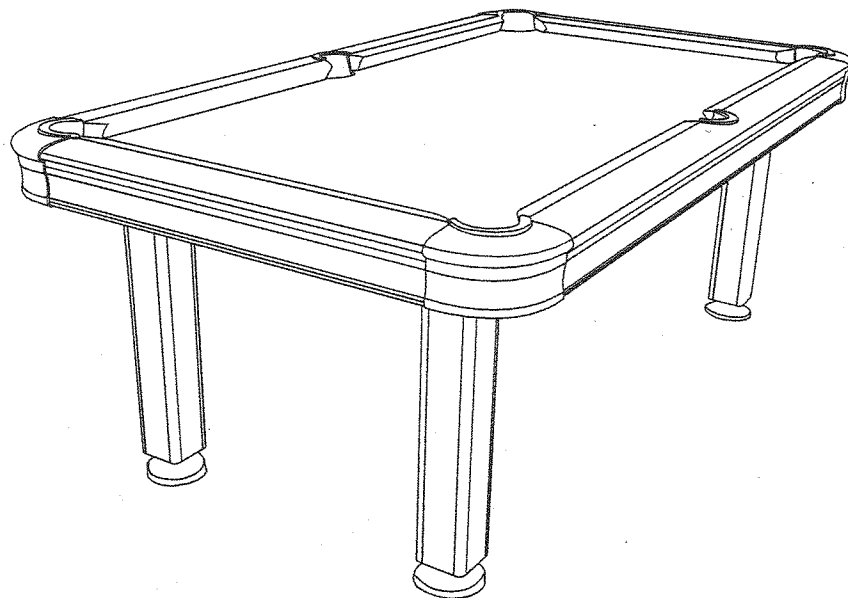

IMPORTANT! READ THIS MANUAL ALL THE WAY THROUGH BEFORE BEGINNING TO PUT YOUR GAME TABLE TOGETHER! THEN READ EACH STEP BEFORE STARTING THAT STEP.

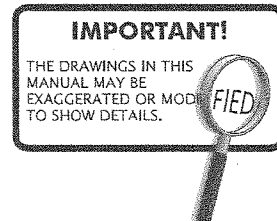

TWO (2) ADULTS ARE REQUIRED TO ASSEMBLE THIS GAME TABLE

Tools Required

Philips Screwdriver
Furniture Polish and Cloth
Allen Wrench included

Assembly Tips

Make sure you understand the following tips before you begin to assemble your Game table











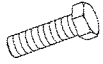

1. When installing parts that have more than one bolt, start **ALL** the bolts in that part by hand before tightening anything.
2. Some drawings or images in this manual may not look exactly like your product. Please read and understand the text before starting each assembly step.

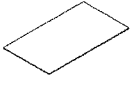

WARNING:

READ AND FOLLOW ALL ASSEMBLY, OPERATION, AND SAFETY INSTRUCTIONS CAREFULLY. AT LEAST TWO ADULTS ARE NEEDED TO PUT THIS GAME TABLE TOGETHER.

PARTS IDENTIFIER

<p>#1</p>  <p>M10X65mm Bolt 16 pieces</p>	<p>#2</p>  <p>M10 Washer 16 pieces</p>	<p>#3</p>  <p>Chalk 2 pieces</p>	<p>#4</p>  <p>Cue 2 pieces</p>
<p>#5</p>  <p>Triangle 1 pieces</p>	<p>#6</p>  <p>Playfield Assy qty 1 piece</p>	<p>#7</p>  <p>Right leg 2 pieces</p>	<p>#8</p>  <p>Left Leg 2 pieces</p>
<p>#9</p>  <p>Table Cover 1 piece</p>	<p>#10</p>  <p>Leg leveler 4 pieces</p>	<p>#11</p>  <p>Wrench 1 piece</p>	<p>#12</p>  <p>Allen wrench 1 piece</p>
<p>#13</p>  <p>Billiard Ball 1 Set</p>			

1. Locate #7 leg to #6 cabinet use #1 Bolts and #2 Whashers tighten.

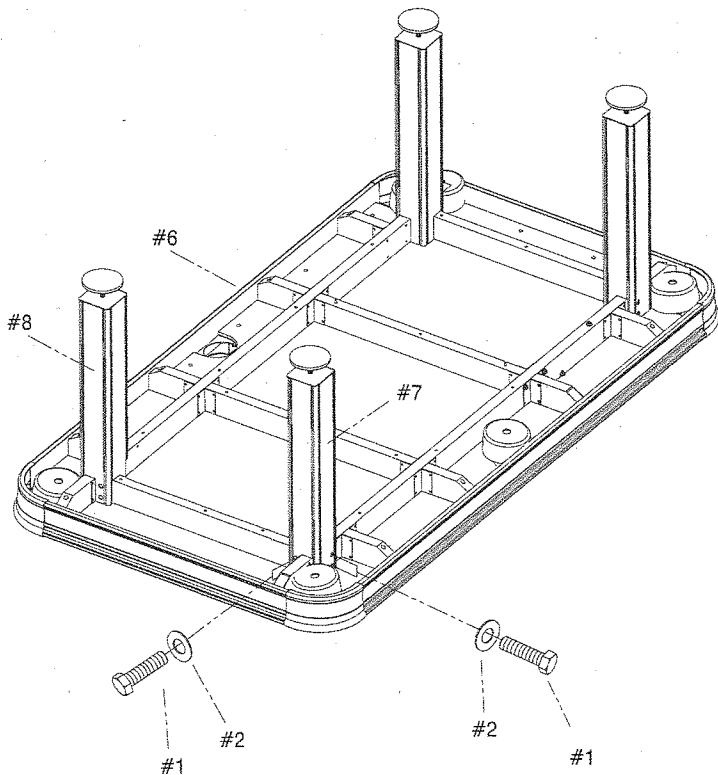

2. Locate #10 Leg leveler to each leg.

Warning: the table is very heavy, please make sure you have 4 adults to turn over this table

