

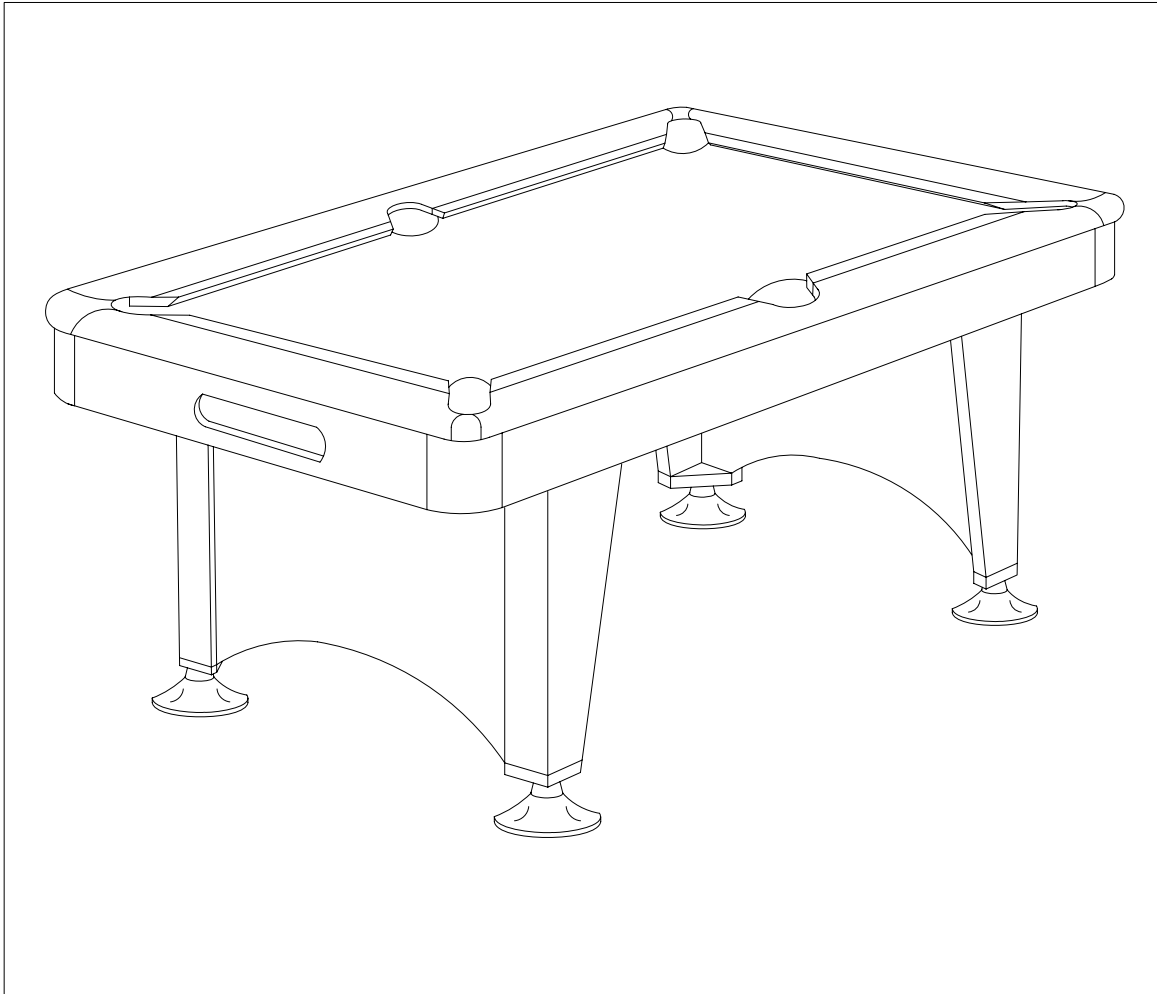

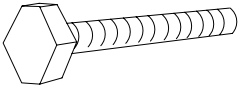

BILLIARD TABLE

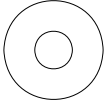
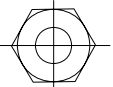
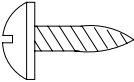
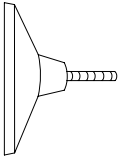
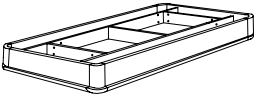
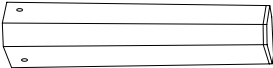
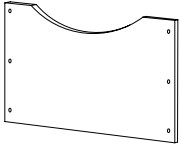
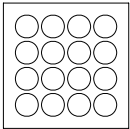
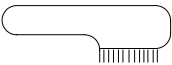
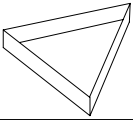

ITEM NO.: 29-700

<u>PICTURE OF PART</u>	<u>DESCRRIPTION OF PART</u>	<u>QTY</u>
	1 Bolt 3/8"X2"	16
	2 Washer 3/8"X25MM	32
	3 Nut 3/8"	16
	4 T4X1" Screw	12
	5 Leg leveler	4
	6 Main frame	1
	7 Leg	4
	8 Leg panel	2
	9 Billiard balls	1
	10 Brush	1
	11 Triangle	1
	12 Chalk	2
	13 Cue stick	2
	14 Wrench	1

Step 1:

